

Haier

More Creation, More Possibilities

Haier

HVAC Solutions

SUPERCLIMA

R32 Inverter Air-Cooled
Modular Chiller





A NEW GENERATION OF CHILLER TECHNOLOGY

There are a number of challenges facing building owners today and meeting energy reduction targets is amongst the most urgent. This along with changes in legislation and the drive to reduce carbon emissions, makes robust, future led technological solutions vital. Chiller systems have been used for decades to deliver controlled climate to buildings, but with this increasing pressure on energy efficiency and running costs, the importance of a low-carbon, cost effective option is vital.

Haier 40 Year History

Haier celebrates 40 years in the HVAC industry coupled with this extensive experience in advanced technology, future thinking initiatives and developments. Established in 1984, Haier Group is a global leading provider of solutions to better life. In the process of sustainable innovation and entrepreneurship and focusing on user experience, Haier has grown from the once collectively owned small factory into an ecosystem that leads the IoT era. As the world's first and only IoT ecosystem brand, Haier has been included on the list of BrandZ™ Top 100 Most Valuable Global Brands for four consecutive years. Haier Smart Home is among the list of Global Fortune 500.



WORLD'S NO.1 MAJOR APPLIANCES BRAND

Haier has been accredited with global No.1 in major household appliances by retail sales from 2008-2023, according to data from Euromonitor.



WORLD'S NO.1 SMART AC BRAND

Haier has been world's No.1 connected air conditioner brand, by retail sales in 2023, according to data from Euromonitor.



TOP 100 MOST VALUABLE BRANDS

Haier, the world's only IoT ecosystem brand on the list for four consecutive years.



TOP 100 GLOBAL CHALLENGERS

With the global landing of the Smart Home ecosystem brand, Haier Smart Home was once again listed on the Fortune Global 500.

The First Commercial Air Conditioning Smart Interconnected Factory in the World

Haier commercial air conditioning smart interconnected factory was officially inaugurated in 2016. This is the 8th interconnected factory of Haier, and is the first commercial air conditioning interconnected factory in the world. This factory has the production capacity of 10 types of commercial air conditioning products, which takes advantages of the superior information processing and smart manufacturing and other technologies, which is redefining the manufacturing standards of commercial air conditioning industry, to meet increasing market demands in an era of personalised customisation.

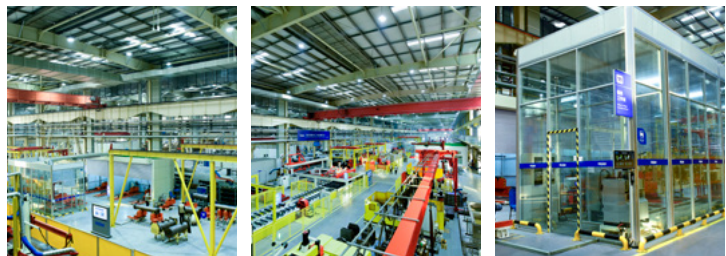

The Drive to Reduce Carbon Emissions

Recent changes in legislation which has been designed to reduce carbon emissions in commercial buildings include the Minimum Energy Efficiency Standards (MEES), Energy Performance Directive and F-Gas regulations.

Currently under MEES from 1 April 2023, landlords must not continue letting a non-domestic property which is already let if that property has an EPC rating of band F or G. It is predicted that MEES will have a gradual, but noticeable effect on the commercial rented property market. Figures show that around 20% of commercial properties fall into the F or G ratings for EPCs, which amounts to around 200,000 non-domestic buildings.

Energy Performance Directive (ErP) - Lot 21 Regulation (EU) 2016/2281

The ErP Directive Lot 21 defines minimum allowable seasonal efficiencies for chiller technology. Both EN 14511 and EN 14825 are used to define how the seasonal efficiency of a system should be tested the seasonal efficiency is then presented as a ratio of SEER and the primary energy conversion factor.

SOURCE	COOLING CAPACITY	MINIMUM EFFICIENCY	
		JAN 2018	JAN 2021
Air Cooled	<400kW	149%	161%
	>400kW	161%	179%
Water Cooled	<400kW	196%	200%
	>400kW / <1500kW	227%	252%
	>1500kW	245%	272%

Information from Official Journal of the European Union EU 2016/2281, Annex II tables 3 and 4

F-GAS Regulations

The European Union is committed to reducing the environmental impact of refrigerants and to lower the consumption and use of HFCs within with a number of industry sectors for which HVAC applications form a part of. The ultimate objective is to cut the availability of HFCs by 79% between 2015 and 2030.

Ban from 2025 on the use of high GWP refrigerant gas

In 2014, The European Union F-Gas Regulation (EU 517/2014) announced the ban of the use of hydrofluorocarbons (HFCs) including R410A in new equipment from January 1, 2020, and set a phasedown of their total quantity in the market.

From January 1, 2025, the use of R410A and other high-GWP HFCs will be further restricted in the European Union under the F-Gas Regulation. This includes a ban on the use of these refrigerants in new equipment, as well as limits on their total quantity that can be placed in the market. As a result, the installation of refrigerant gasses above a GWP of 750 such as R22 and R410A will be prohibited.

At Haier we are continuously investing in research and development to provide solutions which leads the way in driving environmental and sustainable initiatives for both for residential and industrial applications for a greener future.

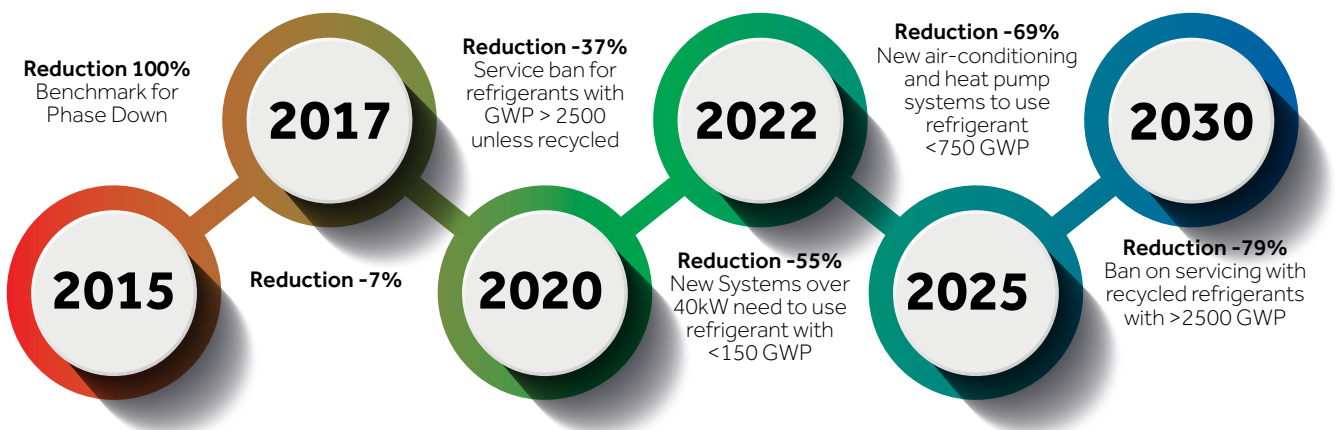

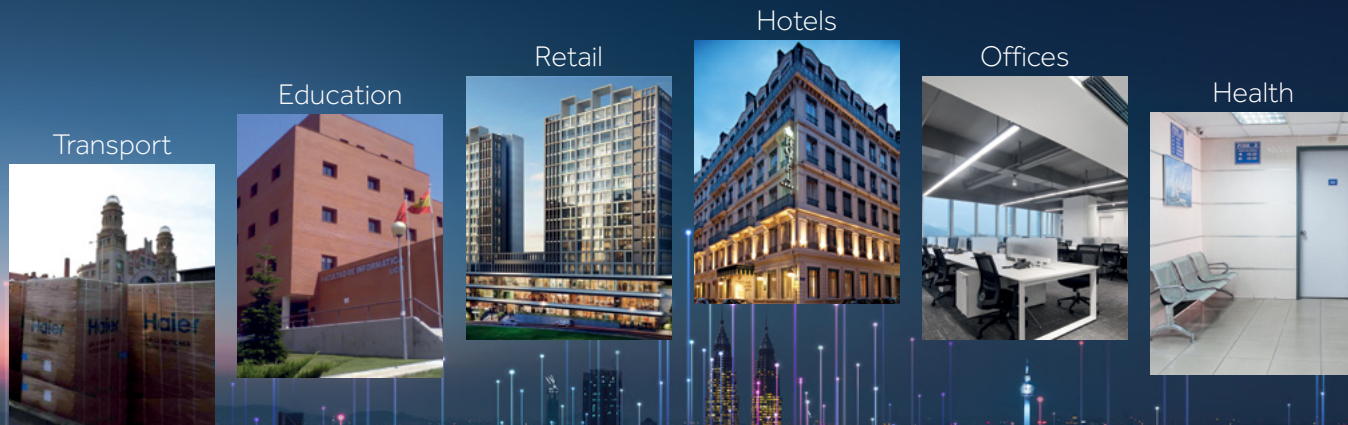

APPLICATIONS

Stand alone or up to 16 Haier modular Chillers of any capacity can be coupled under a single controller in order to reach 2080 KW of capacity. The simplicity of the construction and rational configuration with the various pre-installed protections make these models reliable and economical to manage. Suitable for a wide range of small to large scale commercial applications.

R32 FEATURES

PRODUCT LINE-UP



HAIER SUPER CLIMA R32 MODULAR SERIES

Providing cooling, heating, domestic hot water and high performance with Eco-friendly R32 refrigerant.

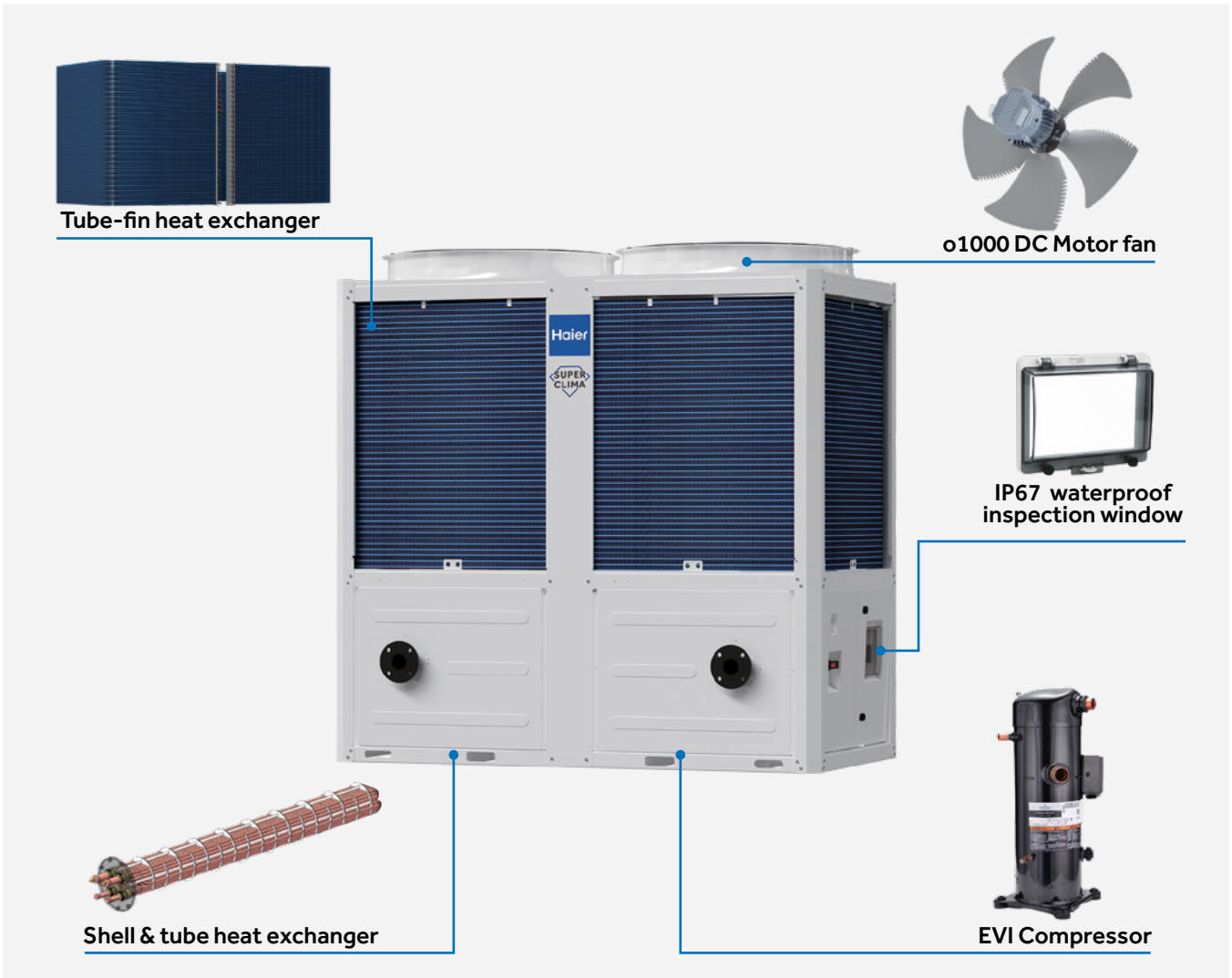

EXCELLENT PERFORMANCE

The R32 modular chiller offer's high efficiency both at full load and all year round operational conditions. Industry leading COP of up to 5.00. A+++ efficiency class @35°C LWT and A+ @ 55°C LWT for space heating.

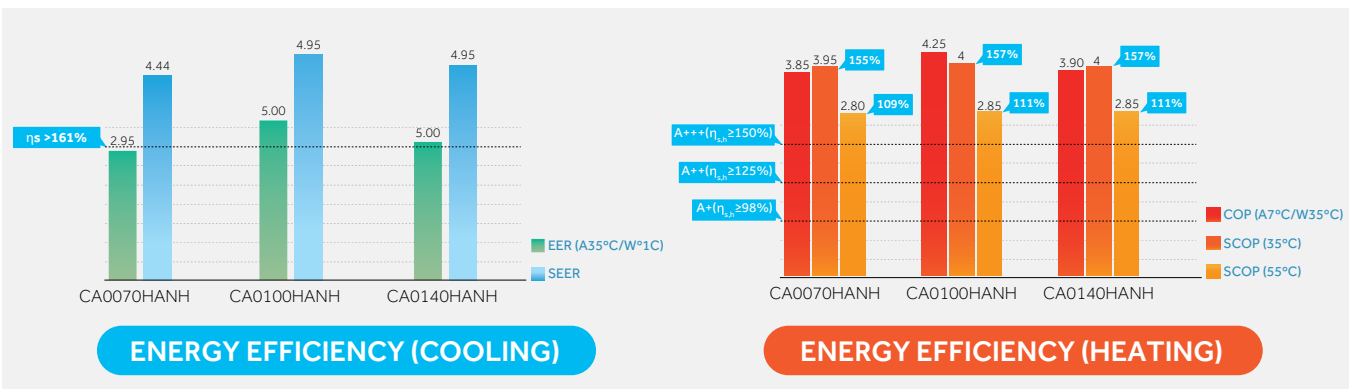

The $\eta_{s,c}$ can be up to 192% which is much higher than the EU Standard. *CA0100HANH

R32 FEATURES

WIDE OPERATING RANGE

The unit operates stably under wide conditions, which is an ideal option for various requirements and applications.

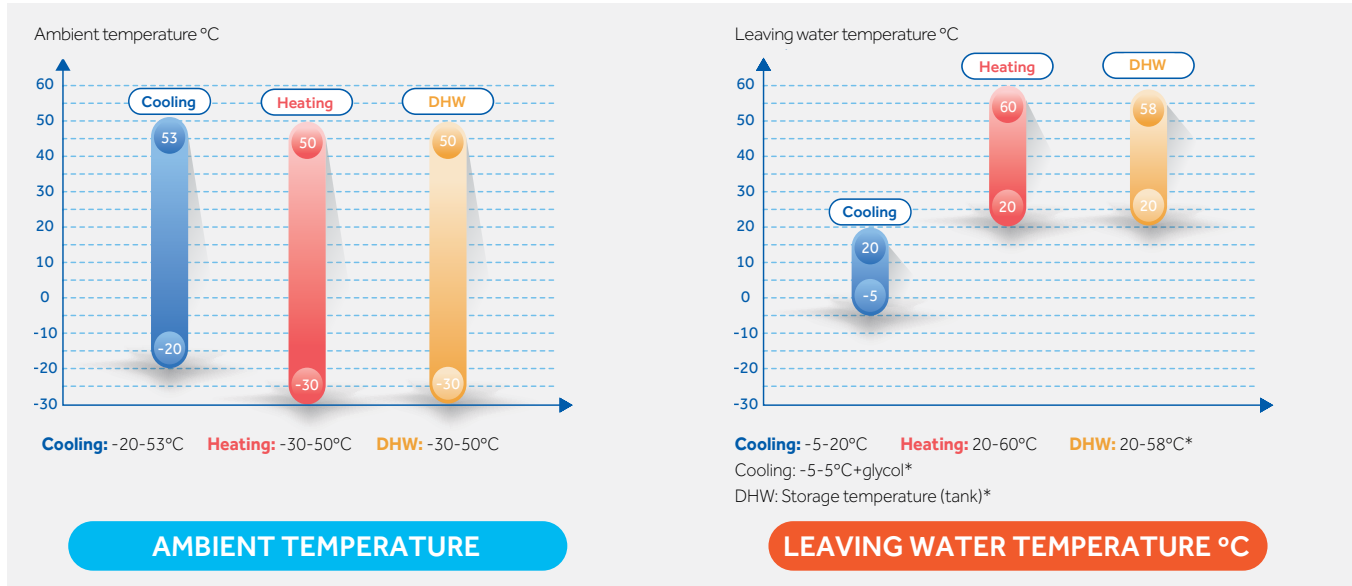

1000 DC MOTOR FAN

The industry's largest diameter axial fans increase air volume and delivers a more effective heat exchange while reducing noise. The trailing edge of the fan blade is designed with a bio-mimetic tooth shape, effectively cutting and combing the airflow at the outlet to achieve reduced wind noise, stable and powerful air output, and quiet operation.

The variable fan speed of the DC motors offer better seasonal performance.

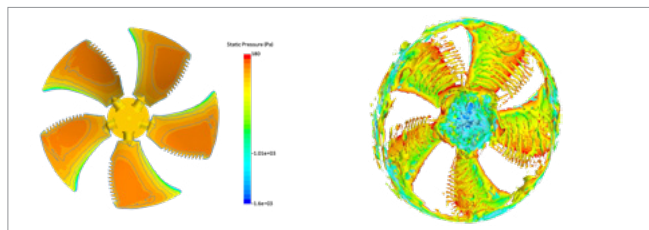

SHELL & TUBE HEAT EXCHANGER

The patented design of the shell & tube heat exchanger significantly enhances the units' anti-frosting and anti-fouling performance. The installation of baffles enhances fluid turbulence, thereby promoting heat transfer between the fluids.

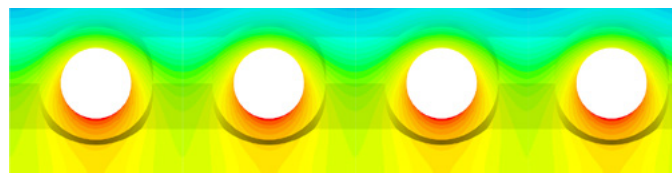

TUBE-FIN HEAT EXCHANGER

The one piece U-shaped heat exchanger enlarges the heat exchanging area by 47% compared to previous generation R420A models, and allows the airflow from 360° directions to improve performance. The inner-threaded copper tubes increases internal turbulence and enhances the heat exchange. The corrugated fins are made of hydrophilic aluminum foil to improve airflow and overall optimises heat exchange efficiency.

Controlled by 2 electronic expansion valves, the refrigerant flow is spread evenly, which results in a more adequate heat transfer.

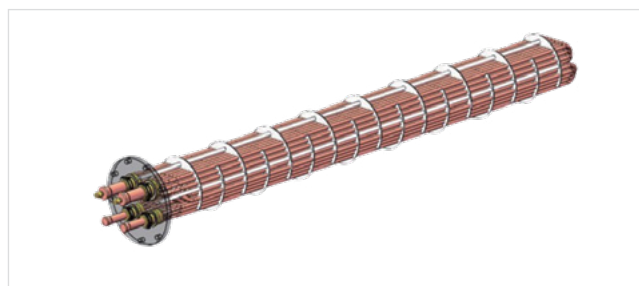
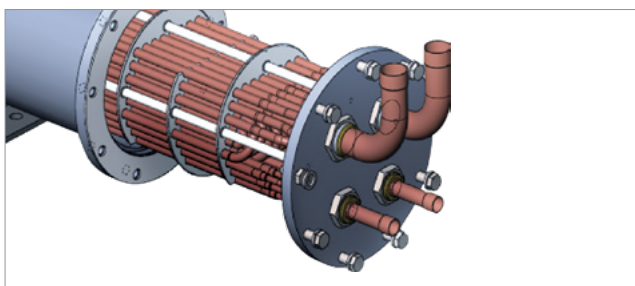

HIGH-EFFICIENCY COMPONENTS RESULTS IN EXCELLENT PERFORMANCE

The latest DC inverter compressor with EVI technology provides excellent "power" for the unit. Uniquely designed with higher compression ratios and larger pressure difference allows the unit to operate reliably even in the harshest ambient conditions. It realises the stepless adjustment of the compressor capacity to achieve precise temperature control.



EVI technology
EVI technology effectively expands the operating ranges for heat pumps with minimum ambient temperature -30°C and increasing energy efficiency.



Optimised design of scroll & VRC technology
Optimised design of scroll & VRC technology allows the volume ratio to match the pressure ratio and aids in offering high efficiency levels for part load conditions.

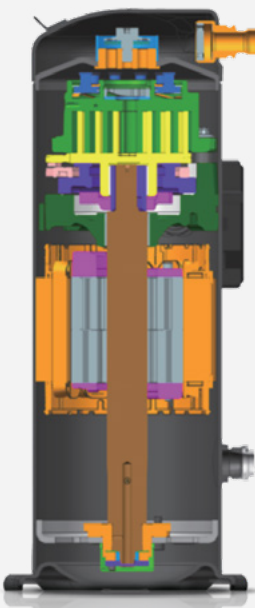



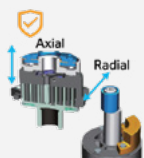

BPM motor
The scroll compressor utilises three-phase brushless permanent magnet(BPM) motor, which improves efficiency while reducing compressor noise.



Fixed scroll & orbiting scroll flexibility
The scroll compressor utilise saxial compliance which allows the fixed scroll to move vertically, by a very small amount, to ensure that the scroll is always radially loaded with optimal force.



Oil pump
The scroll compressor is equipped with an oil pump to ensure an adequate supply of oil to the bearing system throughout the operating process.



"Swing link" eccentric bushing
It can produce a positive sealing force at the flanks of the mating wraps, allowing some load to be supported by the wraps instead of it mostly being supported by the hub bearing and deliver reliability under high speed.

OPERATING ENVELOPE

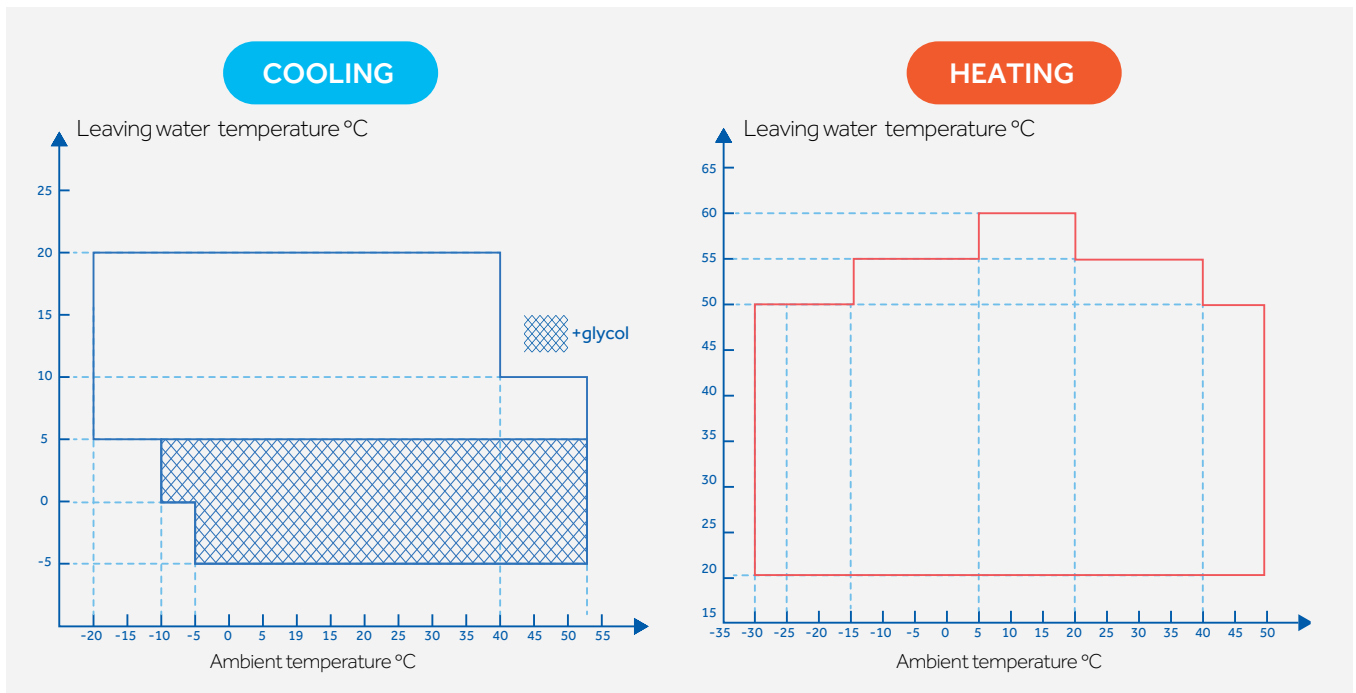

R32 FEATURES

MAX.16 COMBINATION

A maximum of up to 16 units can be connectable into one system to meet larger capacity demands.

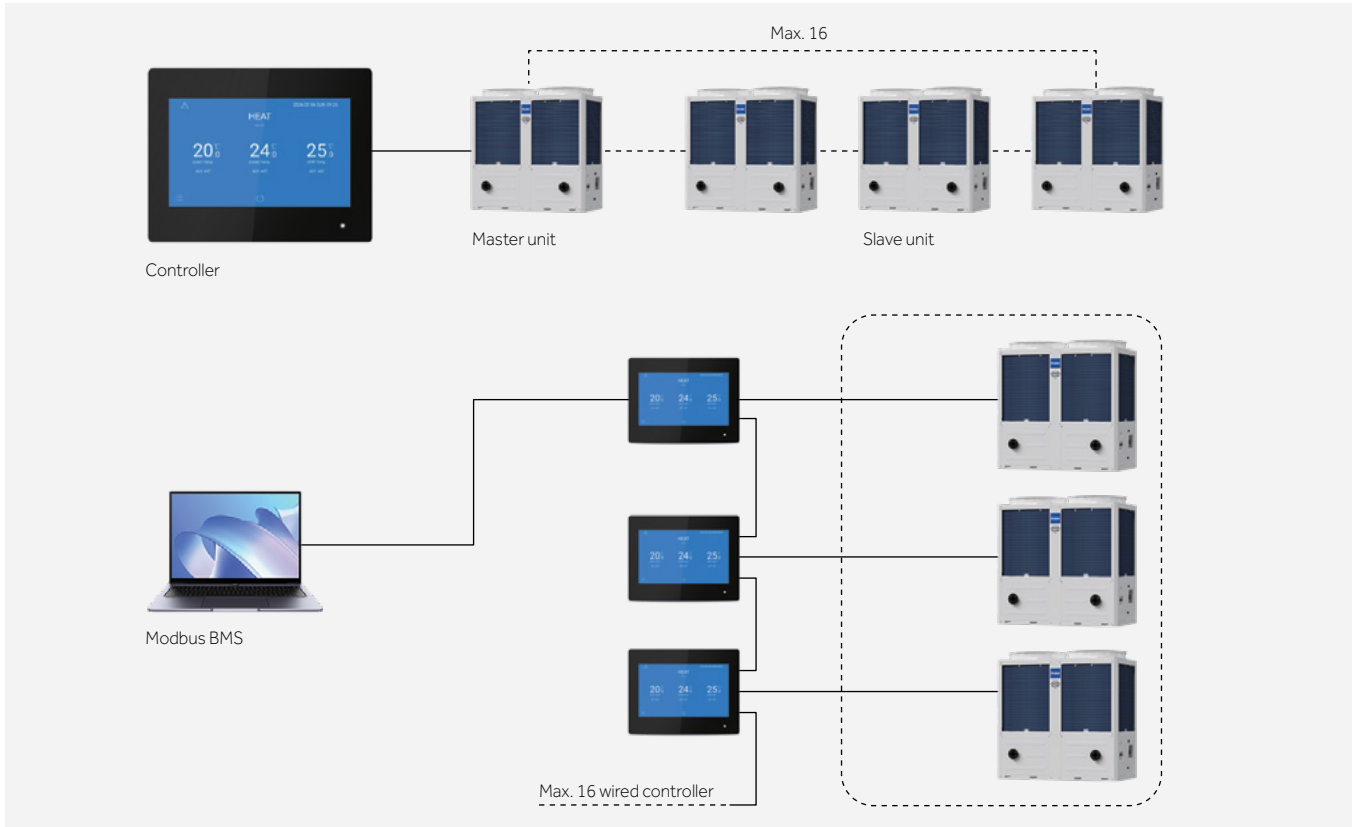

INTELLIGENT DEFROSTING

The module chiller is designed to monitor the refrigerant pressure and temperature so when de-frost is required the PCB detects the heat load recession and controls the defrosting to make sure the chiller maintains optimum operation whilst still achieving rapid defrost.

CA0100HANH and CA0140HANH have two independent refrigerant circuits, this ensures that heating is maintained during defrost mode.

In combination system the defrosting of one of module does not affect the other modules operation. If one unit is defrosting the other heat units, maintaining heating operation this realises non-stop system heating during defrosting.



To cope with blizzards and freezing rain weather, the unit is equipped with centralised drainage and electric heating functions as standard. This ensures that condensate or defrosting water can be quickly discharged to the external unit during severe weather conditions, preventing ice buildup.

LOW SOUND LEVEL

Superior design ensures a number of noise reduction elements have been included in the design to ensure the chiller is always running at a low sound level. Sound proof material have been used around the compressor which further reduces noise levels.

The chiller is mounted on a rubber anti-vibration pad for quiet operation and low vibration and insulation of the removable panels also helps to reduce noise levels.

The brushless DC fan motor and aerodynamically optimised impeller are utilised for noise and vibration reduction. The quiet function additionally reduces fan speed.

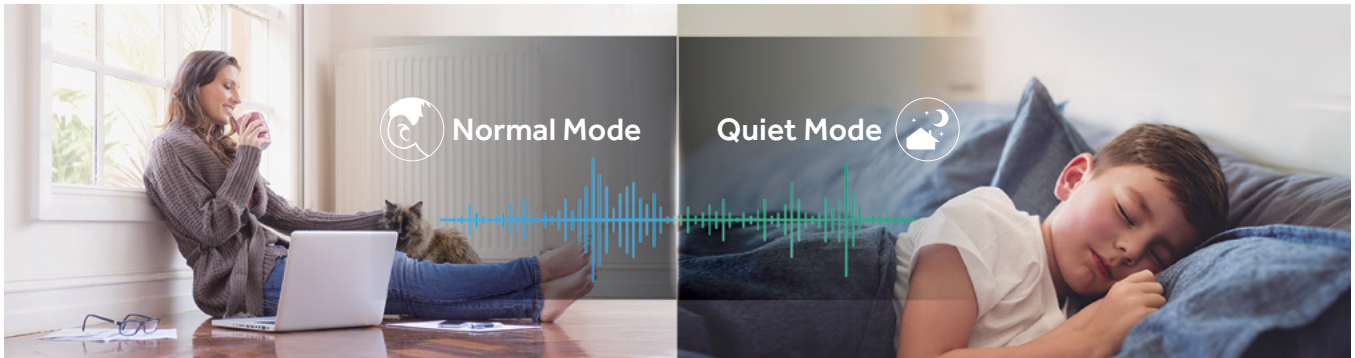

EASY INTALLATION AND MAINTENANCE

Water pipe extension can be easily installed without the need to remove the panels.

The electrical box is placed in the hinged door which makes maintenance and commissioning more convenient.

The unit can control a 3-port valve water side, auxiliary heat source and the electric heater in the DHW tank.

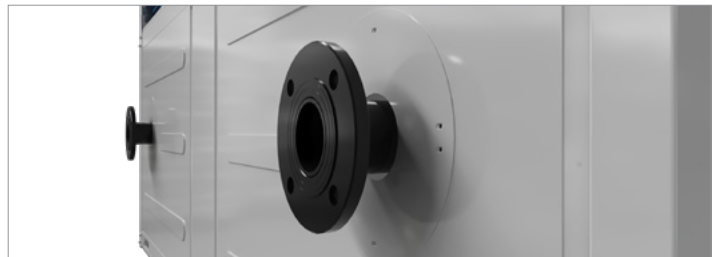

USER-FRIENDLY CONTROLLER

The modular chiller is equipped with a 5-inch touch screen controller that delivers capabilities of controlling and monitoring the unit operations.

Users can easily access the unit operation parameters via a touch screen. These parameters are helpful for after sales service and system diagnostics.

If the control system detects a fault the related code will be recorded, which is convenient for fast troubleshooting.

The control panel supports Modbus protocol, with which the unit can seamlessly connect with the Building Automation System.

SAFETY IS PARAMOUNT

The emergency stop button & built-in circuit breaker provides double safety protection for users and the unit. When the unit is powered on, the self-locking mechanism of the circuit breaker will automatically lock, preventing unauthorised opening of the control box, minimizing the risk of electric shock. In addition, our design protects the power circuit in instances of electrical faults for prolonged chiller operation.

The safety control system has comprehensive protection during operation such as overcurrent, overvoltage and evaporator and condenser anti-freeze protection, as well as discharge temperature overheat protection. Additionally, phase monitoring provides protection against phaseloss, phase reversal, and phase unbalance which provides protection and guarantees a stable operation.

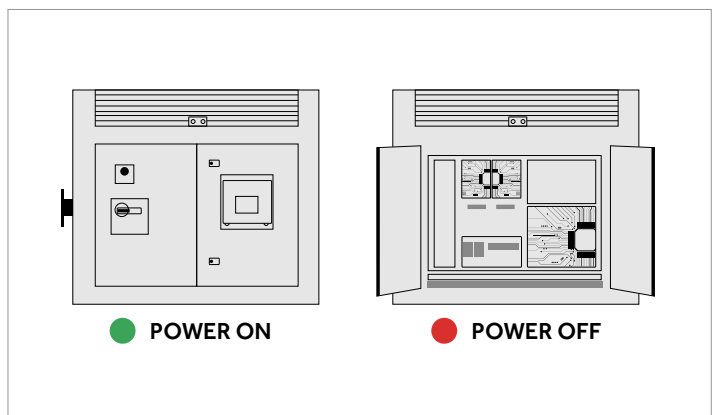

SPECIFICATIONS



DRAFT DATA - Subject to change

Model			CA0070HANH	CA0100HANH	CA0140HANH
Cooling (LWT 7°C/OAT 35°C)	Capacity	kW	65	100	130
	Power Input	kW	22.03	28.60	42.88
	EER	W/W	2.95	3.50	3.03
Cooling (LWT 18°C/OAT 35°C)	Capacity	kW	73	110	145
	Power Input	kW	18.96	23.40	40.28
	EER	W/W	3.85	4.70	3.60
Heating (LWT 35°C/OAT 7°C)	Capacity	kW	71	100	142
	Power Input	kW	16.14	20.00	30.87
	COP	W/W	4.4	5.00	4.60
Heating (LWT 45°C/OAT 7°C)	Capacity	kW	71	100	142
	Power Input	kW	18.93	24.20	36.90
	COP	W/W	3.75	4.13	3.85
Heating (LWT 55°C/OAT 7°C)	Capacity	kW	71	100	142
	Power Input	kW	22.90	29.10	43.50
	COP	W/W	3.1	3.44	3.26
Seasonal Energy Efficiency	SEER	W/W	4.6	4.88	4.82
	ns,c	%	181	192	190
	SCOP (35°C)	W/W	4.51	4.85	4.60
	ns,h	%	178	191	181
	SCOP (55°C)	W/W	3.65	3.85	3.80
Operating Temperature Range	ns,h	%	143	151	149
	Cooling	°C	-20-53	-20-53	-20-53
	Heating	°C	-30-50	-30-50	-30-50
	DHW	°C	-30-50	-30-50	-30-50
Leaving Water Temperature Range	Cooling	°C	-5-20	-5-20	-5-20
	Heating	°C	20-60	20-60	20-60
Storage Temperature Range (Tank)	DHW	°C	20-58	20-58	20-58
Power Supply		Ph/V/Hz	3N-/380-415V/50Hz	3N-/380-415/50	3N-/380-415/50
Sound Power Level		dB(A)	88	88	91
Sound Pressure Level		dB(A)	71	70	72
Waterside Heat Exchanger Type		-	Shell & Tube Heat Exchanger	Shell & Tube Heat Exchanger	Shell & Tube Heat Exchanger
Airside Heat Exchanger Type		-	Copper Tube & Aluminum Fin	Copper Tube & Aluminum Fin	Copper Tube & Aluminum Fin
Refrigerant Throttle Type		-	Electronic Expansion Valve	Electronic Expansion Valve	Electronic Expansion Valve
Compressor	Type		Inverter Scroll Compressor	Inverter Scroll Compressor	Inverter Scroll Compressor
	Quantity		1	2	2
Refrigerant	Type		R32	R32	R32
	Charge	kg	10	11*2	11*2
	CO2e	t	6.75	14.85	14.85
Fan	Type	-	Axial	Axial	Axial
	Motor Type		DC motor	DC Motor	DC Motor
	Airflow Rate	m3/h	25400	20500	25400
	Qty.	-	1	2	2
Water System	Water Resistance	kPa	53	40	60
	Water Flow Rate (Cooling)	m3/h	11.2	17.2	22.4
	Water Flow Rate (Heating)	m3/h	12.2	17.2	24.4
	Max. Pressure	MPa	1	1	1
	Water Pipe Size (Inlet/Outlet)	-	DN50/DN50	DN65/DN65	DN65/DN65
External Dimension	W x D x H	mm	1265 x 1210 x 2260	2260 x 1255 x 2260	2260 x 1255 x 2260
Packing Dimension	W x D x H	mm	1280 x 1230 x 2400	2280 x 1275 x 2400	2280 x 1275 x 2400
Weight	Unit weight	kg	500	910	910
	Gross weight	kg	515	940	940
	Weight in operation	kg	525	940	940

1. Haier reserves the right to change these specifications without prior notice.

2. Ratings calculated according to EN14511 and EN14825.

3. ns calculated according to Ecodesign regulation for chillers comfort cooling and heating (813/2013, 2016/2281)

4. Ecodesign figures are calculated following variable outlet approach.

5. Sound data is tested in Haier lab, which may vary according to different installation conditions.

6. The resistance parameters listed in the table do not account for the resistance of the included water filter.

7. For further information, please contact Haier staff.

EXTERNAL DIMENSION

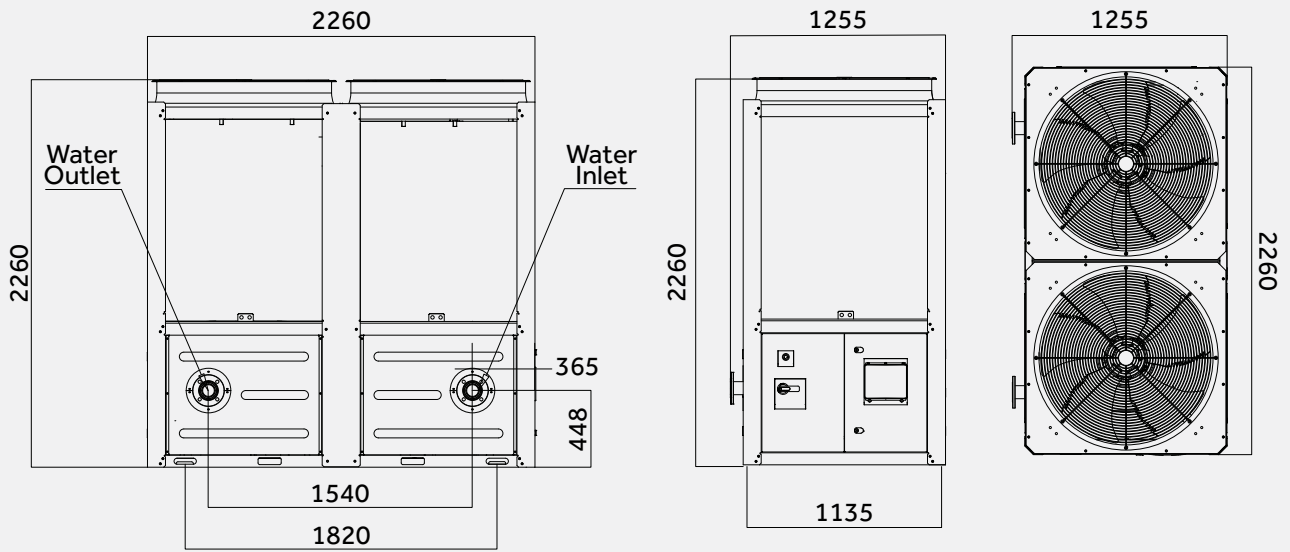

INSTALLATION CLEARANCE (Single Chiller)

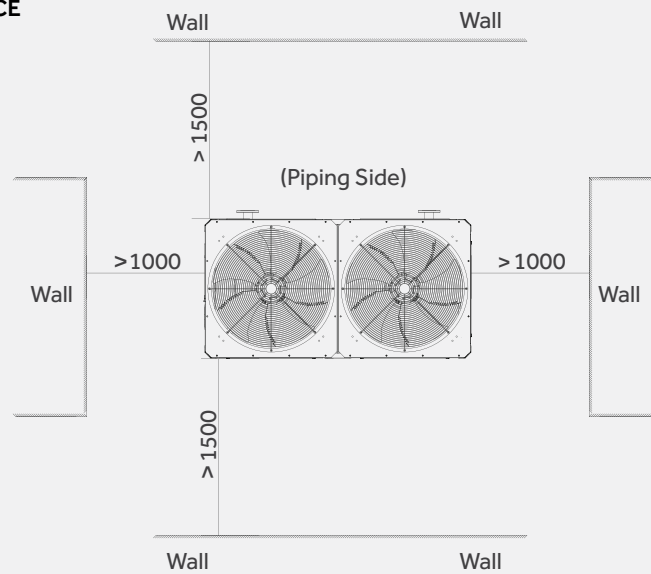

INSTALLATION CLEARANCE (Multiple Chillers)

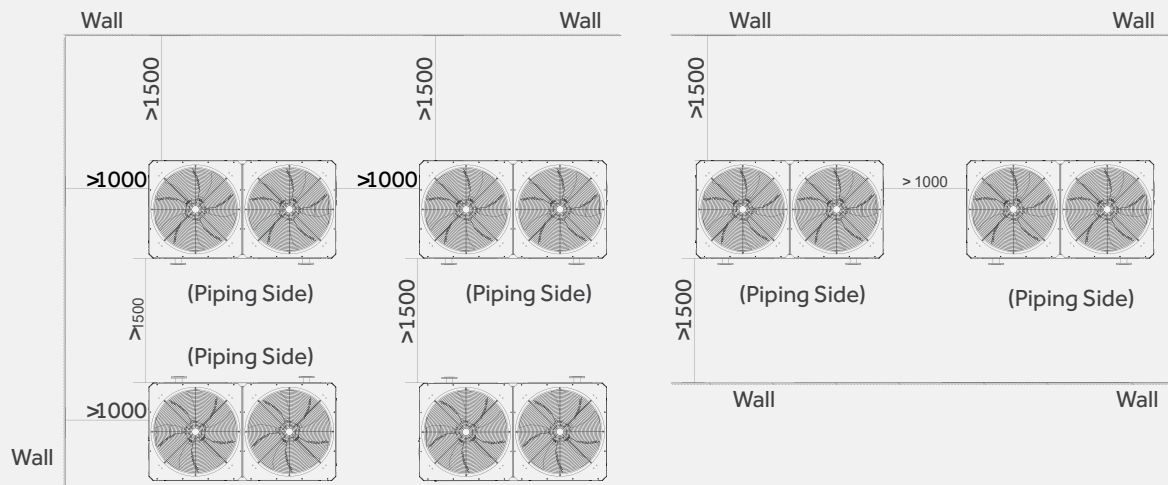

Haier
HVAC Solutions

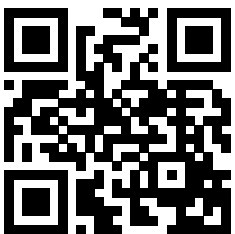

Haier HVAC
haierhvac.eu

Copyright © 2024 Haier. All rights reserved.