

MULTI

Combine up to 5 indoor units



Introduction

Haier's Multi Split system enables you to experience climate comfort in every room.

A Multi system allows up to 5 indoor units to operate from a single outdoor unit, thereby reducing installation space and costs. All indoor units can be controlled independently and does not need to be installed at the same time, the system can be future proofed to allow up to 5 indoor units to one outdoor unit.

Haier's range of indoor units caters for a wide verity of applications, this includes, wall mounted, concealed ceiling, cassettes and floor standing units. These units are available in range of capacities which enables you to accurately size the system according to the needs of the room.

MultiSplit Unit Connectivity

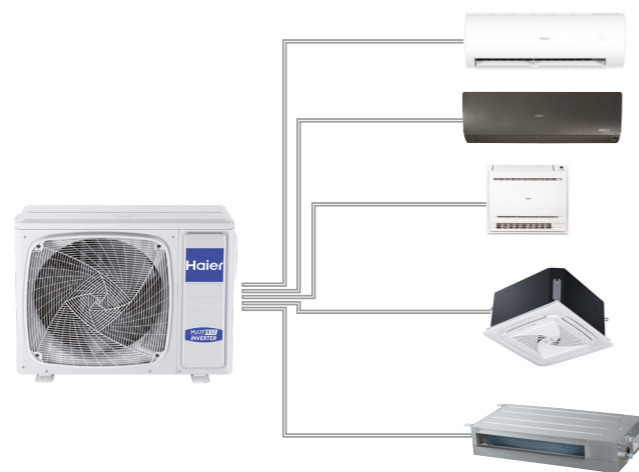

Outdoor Unit



R32 Refrigerant



High Efficiency



Silence



Easy Installation

Features



SELF-CLEAN

Freezes the evaporator with moisture in the air and removes dirt during the defrost process, ensuring healthy air output. Our Self Clean technology is the first of its kind to integrate the self-cleaning function of both the evaporator and the condenser.



HON WI-FI

Enables you to take control of all the Haier group appliances in your Smart Home from a single app on your smartphone or tablet. The hOn app allows you to manage all the basic functions and much more.

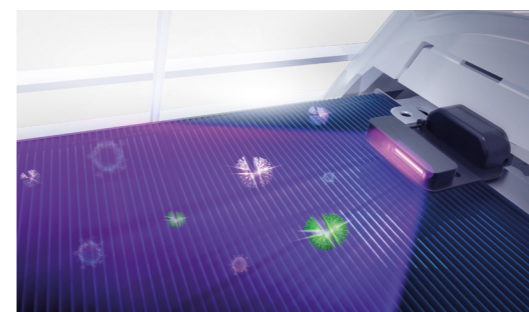

UVC PRO

Inhibits the reproduction of bacteria, by breaking down hydron and oxygen molecule and generates ionic group which inhibits bacteria and sterilises virus after contacting. The module was independently tested by Texcell and inhibits SARS-CoV-2, with an efficiency up to 99.998% in 1 hour (Expert).



EASY INSTALLATION

Installation is simplified, with larger workspaces and easy disassembly and maintenance. Pipes and cables can be connected easily thanks to a removable bottom panel.



SILENCE

Optimised design of fan's air ducts, and motors to be able to deliver cooler, more comfortable air with a low noise level for you to enjoy your indoor space.











ECO SENSOR















Detects the condition of air and people's movement in real time, adjusting the operating mode of the air conditioner to improve energy efficiency and optimise the users experience. It uses a double area detection with a maximum angle of 120 degrees and a distance of 8m.

Compatibility











Residential MultiSplit Inverter









Haier









INDOOR UNITS MULTI-SPLIT R32						
SERIES	2,0 kW	2,5 kW	3,5 kW	5,0 kW	6,8 / 7,1 kW	
JADE		 AS25S2SJ1FA-3	 AS35S2SJ1FA-3	 AS50S2SD1FA-3		
	 I Feel	 2-Way Piping Design	 Self Hygiene	 Silence	 Wi-Fi control integrated	 Easy Installation



EXPERT Black & White	 AS20XCAHRA	 AS25XCAHRA	 AS35XCAHRA	 AS50XCAHRA	 AS71XCAHRA
	 AS20XCAHRA-MB	 AS25XCAHRA-MB	 AS35XCAHRA-MB	 AS50XCAHRA-MB	 AS71XCAHRA-MB
	 Easy Installation	 I Feel	 Self Clean	 Coanda Plus	 Eco Sensor







FLEXIS PLUS Black & White	 AS20S2SF1FA-MB3	 AS25S2SF1FA-MB3	 AS35S2SF1FA-MB3	 AS50S2SF1FA-MB3	 AS71S2SF1FA-MB3
	 AS20S2SF1FA-MW3	 AS25S2SF1FA-MW3	 AS35S2SF1FA-MW3	 AS50S2SF1FA-MW3	 AS71S2SF1FA-MW3
	 I Feel	 Eco Sensor	 Easy Installation	 Silence	 Wi-Fi control integrated









PEARL PREMIUM	 AS20PBAHRA	 AS25PBHRA -PRE	 AS35PBAHRA -PRE	 AS35PDPHRA -PRE	 AS71PEPHRA -PRE
	 Coanda Plus	 Self Clean	 Silence	 UVC Sterilisation	 Wi-Fi control integrated









REVIVE PLUS		 AS25RBAHRA-3	 AS35RBAHRA-4	 AS50RCBHRA-4	 AS68DAHRA-4
	 Coanda Plus	 Self Clean	 Wi-Fi control integrated	 Easy Installation	 I Feel









INDOOR UNITS MULTI-SPLIT R32					
SERIES	2,5 kW	3,5 kW	4,2 kW	5,0 kW	7,1 kW
CONSOLE	 AD25S2SD1FA(D)	 AD35S2SD1FA(D)	 AD42S2SD1FA(D)	 AD50S2SD1FA(D)	
	 Silence	 Double Flow	 R32 Detector	 Sleep	 Wi-Fi control integrated

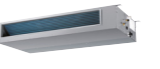







CASSETTE 620	 AB25S2C2FA(H)	 AB35S2C2FA(H)		 AB50S2C2FA(H)	
	 Silence	 4way Independent	 Wi-Fi control integrated	 Fresh Air	 On-Off Card

ROUND FLOW CASSETTE					 AB71S2SG1FA(H)
	 Silence	 8Way Independent	 Wi-Fi control integrated	 Fresh Air	 UVC Sterilisation

CEILING FLOOR	 AC25S2SG1FA(H)	 AC35S2SG1FA(H)		 AC50S2SG1FA(H)	 AC71S2SG1FA(H)
	 Silence	 Flow +	 5 Speed Fan	 Fresh Air	 On-Off Card

SLIM DUCT LOW PRESSURE	 AD25S2SS1FA(H)	 AD35S2SS1FA(H)		 AD50S2SS1FA(H)	 AD71S2SS1FA(H)
	 Silence	 Compact Design	 3D	 Condensate Drain Pump	 Flexible Installation

DUCTED MEDIUM PRESSURE		 AD35S2SM3FA(H)		 AD50S2SM3FA(H)	 AD71S2SM3FA(H)
	 Silence	 Compact Design	 Fresh Air	 Condensate Drain Pump	 Easy installation

ONE-WAY CASSETTE	 AD25S2SA1F1(H)	 AD35S2SA1FA(H)		 AD50S2SA1FA(H)	 AD71S2SA1FA(H)
	 Compact Design	 Fresh Air	 UVC Sterilisation	 Wi-Fi control integrated	

Compatibility

Residential MultiSplit Inverter

4,0 kW 7,0 kW 10,5 kW
5,0 kW 8,5 kW 12,5 kW
5,5 kW 9,0 kW

Haier



SELF-CLEAN
1:2 2U40S2SM1FA
2U50S2SM1FA-3



1:3 3U55S2SR5FA
3U70S2SR5FA



1:4 4U75S2SR5FA
4U85S2SR5FA



1:5 5U90S2SS5FA
5U105S2SS5FA
5U125S2SN1FA

Outdoor Unit	Model	2U40S2SM1FA	2U50S2SM1FA-3	3U55S2SR5FA	3U70S2SR5FA	4U75S2SR5FA	4U85S2SR5FA	5U90S2SS5FA	5U105S2SS5FA	5U125S2SN1FA
Performance data										
Output power - COOLING	nom (min-max) KW	4,00 (1,00-4,50)	4,60 (1,30-6,00)	5,50 (2,10-7,00)	7,00 (2,40-7,60)	7,50 (2,40-8,70)	8,50 (3,20-9,50)	9,00 (3,20-11,00)	10,00 (3,20-11,00)	12,50 (3,20-13,80)
Output power - HEATING	nom (min-max) KW	4,00 (1,50-4,80)	5,20 (1,60-6,50)	6,80 (1,70-7,60)	7,60 (2,90-8,50)	8,60 (3,10-10,00)	9,60 (4,40-10,50)	10,40 (4,40-11,50)	10,50 (4,40-11,50)	12,70 (4,40-14,30)
Absorbed power - COOLING	nom (min-max) KW	0,89 (0,30-1,65)	1,07 (0,35-2,01)	1,35	1,84	1,97	2,50	2,79	3,47	3,87
Absorbed power - HEATING	nom (min-max) KW	0,98 (0,38-1,80)	1,21 (0,52-2,00)	1,66	1,85	2,15	2,40	2,79	2,82	3,40
Energy class	EER	4,50	4,30	4,00	3,81	3,80	3,40	3,23	2,88	3,23
	COP	4,50	4,30	4,10	4,10	4,00	4,00	3,73	3,73	3,73
COOLING Pdesign	35 °C KW	4,00	4,60	5,50	7,00	7,50	8,00	9,00	10,00	12,50
HEATING Pdesign	(-10 °C) KW	3,70	3,80	4,70	6,00	6,30	7,00	7,20	8,00	9,50
Energy class	SEER	8,50 (A+++)	8,50 (A+++)	8,50 (A+++)	7,50 (A++)	7,00 (A++)	7,00 (A++)	7,00 (A++)	7,00 (A++)	7,10 (A++)
	SCOP	4,60 (A++)	4,60 (A++)	4,00 (A+)	4,20 (A+)	4,00 (A+)	4,00 (A+)	4,00 (A+)	4,00 (A+)	4,05 (A+)
Annual Energy Consumption - COOLING	kWh/a	165	189	227	332	379	456	457	537	622
Annual Energy Consumption - HEATING	kWh/a	1126	1157	1678	2012	2179	2503	2441	2889	3346

Outdoor Unit										
Power supply		Ph/V/Hz	1/220 (240/50/60)							
Power cable		N x mm ²	3 x 2,5	3 x 2,5	3 x 4,0	3 x 4,0	3 x 4,0	3 x 4,0	3 x 4,0	3 x 4,0
Interconnection cable		N x mm ²	4 x 1,0	4 x 1,0	4 x 2,5	4 x 2,5	4 x 2,5	4 x 2,5	4 x 2,5	4 x 2,5
Air Volume		m ³ /h	2200	2400	3000	3000	4000	4000	4 200	4 200
Sound power		dB	62	63	64	66	68	68	70	70
Sound pressure		dB(A)	56	56	51	53	55	55	55	58
Running current cooling/heating	Max	A	7,4/8,2	9,0/8,9	10,8/9,5	11,9/9,7	14,7/13,5	15,5/14,6	18,2/14,6	23,0/18,7
Starting current cooling/heating	Max	A	1,0/1,0	1,0/1,0	4,0/4,0	4,0/4,0	5,0/5,0	5,0/5,0	5,0/5,0	5,0/5,0
Net dimensions	WxDxH	mm	800x280x550	800x280x550	890x340x700	890x340x700	890x340x700	890x340x700	920x372x765	950x370x965
Packaging dimensions	WxDxH	mm	908x405x625	908x405x625	1010x455x835	1010x455x835	1010x455x835	1010x455x835	1045x488x890	1050x485x1170
Net/gross weight		kg	34,0/37,0	36,0/39,0	50,0/59,0	54,0/63,0	61,0/70,0	61,0/70,0	66,0/77,0	79,0/91,0
Compressor type			Twin rotary inverter							

Installation data										
Refrigerant			R32	R32	R32	R32	R32	R32	R32	R32
Liquid pipe	Ø	mm (Inch)	2x6,35 (3x1/4)	2x6,35 (3x1/4)	3x6,35 (3x1/4)	3x6,35 (3x1/4)	4x6,35 (4x1/4)	4x6,35 (4x1/4)	5x6,35 (5x1/4)	5x6,35 (5x1/4)
Gas pipe	Ø	mm (Inch)	2x9,52 (3x3/8)	2x9,52 (3x3/8)	3x9,52 (3x3/8)	3x9,52 (3x3/8)	3x9,52+1x12,70 (3x3/8+1x1/2)	3x9,52+1x12,70 (3x3/8+1x1/2)	3x9,52+2x12,70 (3x3/8+2x1/2)	3x9,52+2x12,70 (3x3/8+2x1/2)
Standard pipe length without refrigerant charge	m		5	5	30	30	40	40	40	50
Maximum pipe length	m		20 (single) 30 (double)	20 (single) 30 (double)	50	60	70	70	80	100
Maximum IU - OU elevation	m		15	15	15	15	15	15	15	15
Maximum IU - OU elevation	m		7,5	7,5	7,5	7,5	7,5	7,5	7,5	7,5
Refrigerant charge in the factory	kg		1,00	1,10	1,40	1,60	1,60	2,20	2,40	2,50
Refrigerant charge in the factory	TCO _{2eq}		0,68	0,74	0,95	1,08	1,08	1,49	1,62	1,69
Additional ref. charge over std length	g/m		20	20	20	20	20	20	20	20
Outdoor operating limits - COOLING	min-max °C		-10° - 43°C				-10° - 46°C			

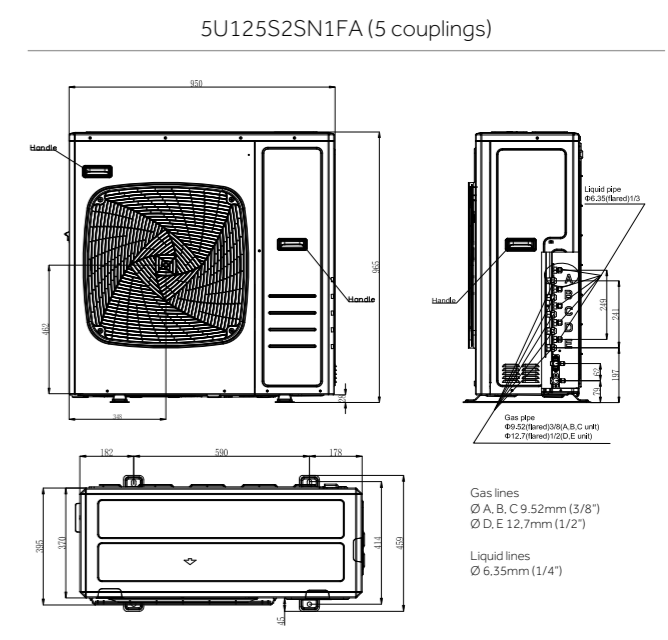
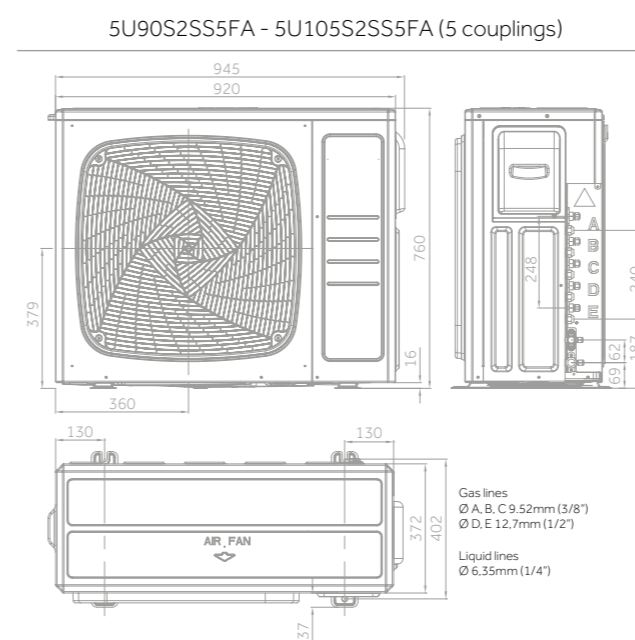
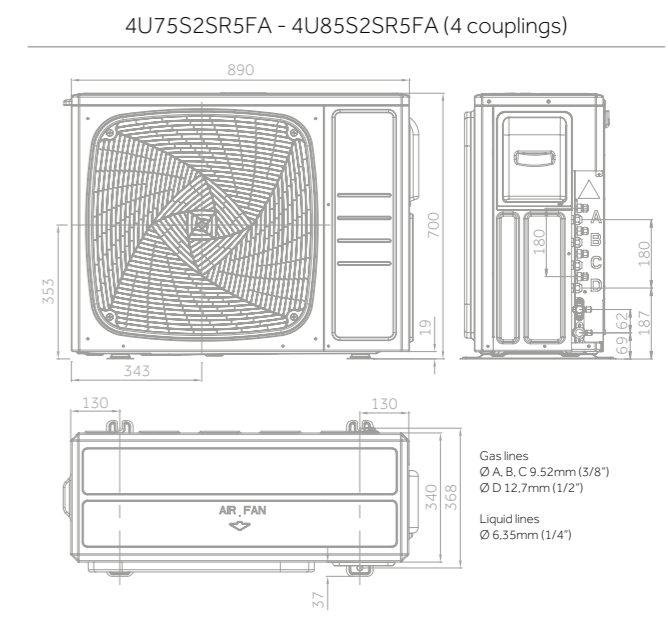
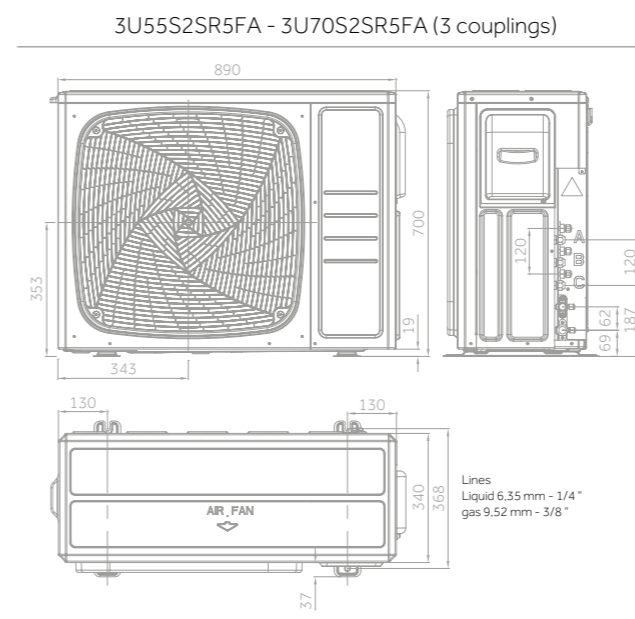
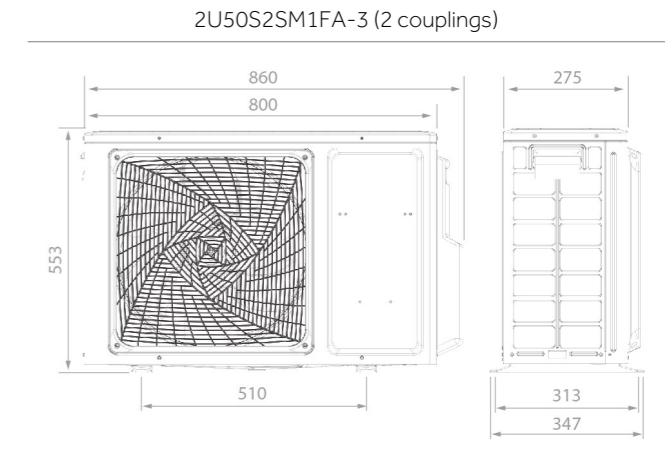
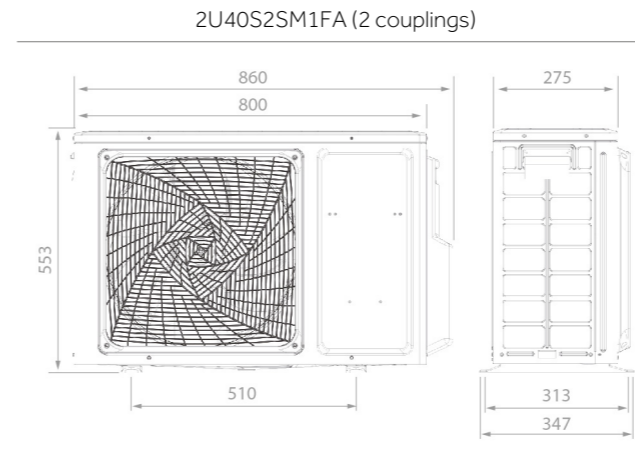

Haier
HVAC Solutions



MULTI

Residentiel MultiSplit Inverter



Haier HVAC
haierhvac.eu